



ISO 9001



Oil Burner Controls

LAL...

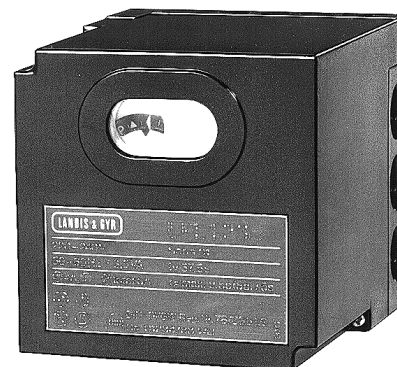

Oil burner controls

- With / without air pressure check for checked air damper control
- Flame supervision with
 - photoresistive detectors QRB1...
 - blue-flame detectors QRC1..., or
 - selenium photocell detectors RAR...

The oil burner controls LAL... are tested and certified to EN 230. They carry the CE mark in compliance with the directives for electromagnetic compatibility!

The LAL... and this data sheet are intended for use by OEMs which integrate the burner controls in their products!

Use

- Control and supervision of oil atomization burners
- For burners of medium to high capacity
- For intermittent operation (at least one controlled shutdown every 24 hours)
- Universally applicable for multistage or modulating burners
- For burners of stationary air heaters (WLE to DIN 4794)

LAL1...	– Yellow- and blue-flame burners without air pressure supervision
LAL2...	– Yellow-flame burners with air pressure supervision
LAL3.25	– For special applications, e.g. burners of incinerator plants (refer to «Type summary» and «Notes»)
LAL4...	– Yellow- and blue-flame burners with air pressure supervision

For burner controls used with burners in continuous operation, refer to data sheet 7785 (types LOK16...).

Warning notes



To avoid injury to persons, damage to property or the environment, the following warning notes must be observed!

- LAL... are safety devices. It is therefore not permitted to open, interfere with or modify the units!
- The unit must be completely isolated from the mains supply before performing any wiring changes in the connection area of the LAL...!
- Check all safety functions when putting the burner control into operation or after performing service work!
- Ensure protection against electric shock on the unit itself and on all electrical connections through appropriate mounting!
- Always press lockout reset button manually, without using any tools or pointed objects!

Mounting notes

-
- In the geographical areas where DIN standards are in use, the installation must be in compliance with VDE requirements, particularly with the standards DIN / VDE 0100 and 0722! In all other areas in compliance with national and local standards and regulations.
 - All regulations and standards applicable to the particular application must be observed!

Installation notes

-
- Installation and commissioning work may only be carried out by qualified personnel!
 - Observe the notes on the laying of detector cables (refer to «Technical data»)!
 - Ignition cables must always be run separate from the unit and other cables while observing the greatest possible distances!
 - Check wiring carefully before putting the burner control into operation!

Engineering notes

- Electromagnetic emissions must be checked from an application point of view!
- Switches, fuses, earthing, etc., must be installed in compliance with local regulations!
- Valves and other components must be connected as specified in the documentation provided by the burner manufacturer!

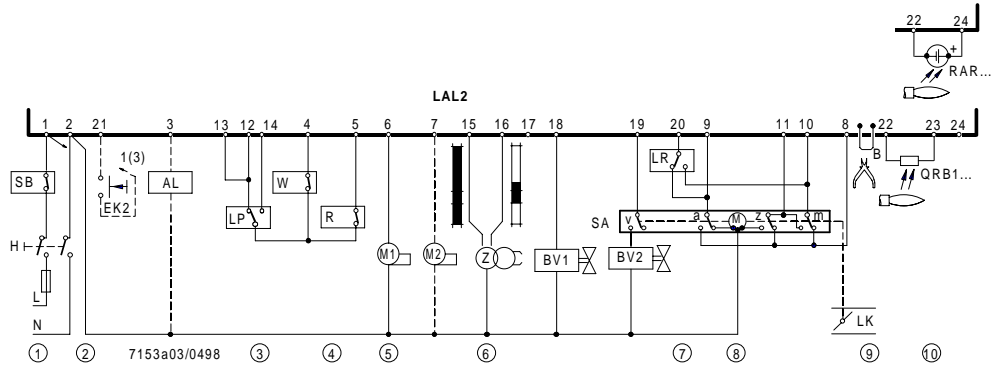

①	Live and neutral may not be interchanged!	Connect safety limit thermostat in the line – Manual reset (e.g. «SB»)
②	Remote reset	When connecting button «EK2» from terminal 21 to – terminal 3, only remote reset – terminal 1, remote reset and remote emergency shutdown
③	With LAL...: Required switching capacity	of switching devices connected between terminals 4 and 5 max. AC 1 A
	With LAL2... / LAL 3... / LAL 4...: Required switching capacity	– of switching devices connected between terminal 12 and «LP» – of «LP» max. AC 1 A max. AC 5 A
④	Control contacts of other devices in the burner plant must be connected as follows (when using series connection):	
	To terminal 4 or 5	Contacts which must be closed from startup to controlled shutdown ⇒ Otherwise no start or shutdown
	To terminal 12 (not with LAL1...)	Contacts which must only be closed on startup ⇒ Otherwise no startup
	To terminal 14 (not with LAL1...)	Contacts which must be closed no later than at the beginning of «t3» or «t3'», and which must remain closed until controlled shutdown occurs ⇒ Otherwise lockout
⑤	Maximum amperage	Refer to «Technical data»
⑥	«Z» connected to terminal 15	«t3'» and «t3n»
⑦	Connection of «BV...» to terminal 20	Refer to «Application examples»
⑧	When using a burner without air damper , or with an air damper not controlled and supervised by the LAL..., terminal 8 must be connected to terminal 6!	
⑨	Wire link «B» (clearly marked on the underside of the LAL...)	When wire link «B» is fitted, the LAL... initiates lockout if flame failure occurs during operation. For repetition of the startup sequence, wire link «B» on the plug-in section of the LAL... must be cut away; just cutting is not permitted!
⑩	For permissible length and laying of detector lines , refer to «Flame supervision»	

Mechanical design

LAL...

- Plug-in design
- Exchangeable unit fuse (incl. spare fuse)

LAL3.25

- Differences to LAL1... / LAL2... / LAL4...
- Extraneous light does not trigger lockout
 - during burner off times
 - during the pre-purge time
 - Extraneous light prevents burner startup

Housing

- Made of impact-proof and heat-resistant black plastic
- Lockout reset button with viewing window, located behind it are:
 - The lockout warning lamp
 - The lockout indicator
 - coupled with the program spindle
 - visible in the transparent lockout reset button
 - uses easy-to-remember symbols to indicate the type of fault and the point in time lockout occurred

Base

- Base and plug-in section of the LAL... are designed such that **only** burner controls of the LAL... type can be plugged in
- With 24 connection terminals
- With auxiliary terminals «31» and «32»
- With 3 earth terminals in the form of a lug for earthing the burner
- With 3 neutral terminals
 - prewired to terminal 2
- With 14 knockout holes for the cable entry by means of cable glands
 - 8 at the side
 - 6 in the bottom of the base
- With 6 lateral knockout holes (threaded) for cable entry glands Pg11

Type summary

Switching times are given in the burner startup sequence, valid for 50 Hz mains frequency. At 60 Hz, the switching times are about 20 % shorter.

	Flash steam generators	Universal application	Medium and heavy oil burners
Flame supervision with QRB1... or QRC1... for blue-flame burners		LAL1.25 LAL4.25A27	
Flame supervision with QRB1... or RAR... Possibility of air pressure supervision Possibility of semi-automatic startup	LAL2.14	LAL2.25	LAL2.65
Same as LAL2.25 with the following exception: extraneous light does not cause burner lockout, but prevents burner startup		Special application, e.g. incinerator plants LAL3.25	
t1	10 s	22.5 s	67.5 s
t2	4 s	5 s	5 s
t3	2 s	2.5 s	2.5 s
t3'	from start 1)	from start 1)	from start 1)
t3n	10 s	15 s	15 s
t4	8 s	7.5 s	7.5 s
t5	4 s	7.5 s	7.5 s
t6	10 s	15 s	15 s
t7	2 s	2.5 s	2.5 s
t8	30 s	47.5 s	92.5 s
t10	6 s	10 s	10 s
t11	optional	optional	optional
t12	optional	optional	optional
t13	10 s	15 s	15 s
t16	4 s	5 s	5 s
t20	32 s	35 s	12.5 s

1) With air pressure supervision: from the time the air pressure signal is received

Technical data

Operating voltage	AC 230 V -15 / +10 %	Power consumption	AC 3.5 VA
With LAL2... also AC 100 V -15 %...AC 110 V +10 %		Mounting position	optional
		Degree of protection	IP 40
Mains frequency	50 Hz -6 %...60 Hz +6 %		
Unit fuse (built-in)	T6,3H250V to IEC 127	Permissible input current	
Prefuse (external)	max. 10 A	at terminal 1	AC 5 A continuously peaks of max. 20 A
Weight		Permissible amperage	
- Burner control	approx. 1000 g	at control terminals 3, 6, 7, 9...11, 15...20	
- Base	approx. 165 g		4 A continuously peaks up to 20 A total max. AC 5 A
QRB1...	refer to data sheet 7714		
QRC1...	refer to data sheet 7716		
RAR...	refer to data sheet 7713	Required switching capacity of switching devices	
		- Connected between terminals 4 and 5	AC 1 A
		- Connected between terminals 4 and 12	AC 1 A
		- Connected between terminals 4 and 14	AC 5 A peaks of 20 A

Environmental conditions

Transport

IEC 721-3-2	
Climatic conditions	class 2K3
Temperature range	-50...+60 °C
Humidity	< 95 % r.h.
Mechanical conditions	class 2M2

Operation

IEC 721-3-3	
Climatic conditions	class 3K5
Temperature range	-20...+60 °C
Humidity	< 95 % r.h.
Mechanical conditions	class 3M2

Condensation, formation of ice and ingress of water are not permitted!



CE conformity

According to the directives of the European Union	
Electromagnetic compatibility EMC	89 / 336 EMC incl. 92 / 31 EEC
Low voltage directive	73 / 23 EEC

Function

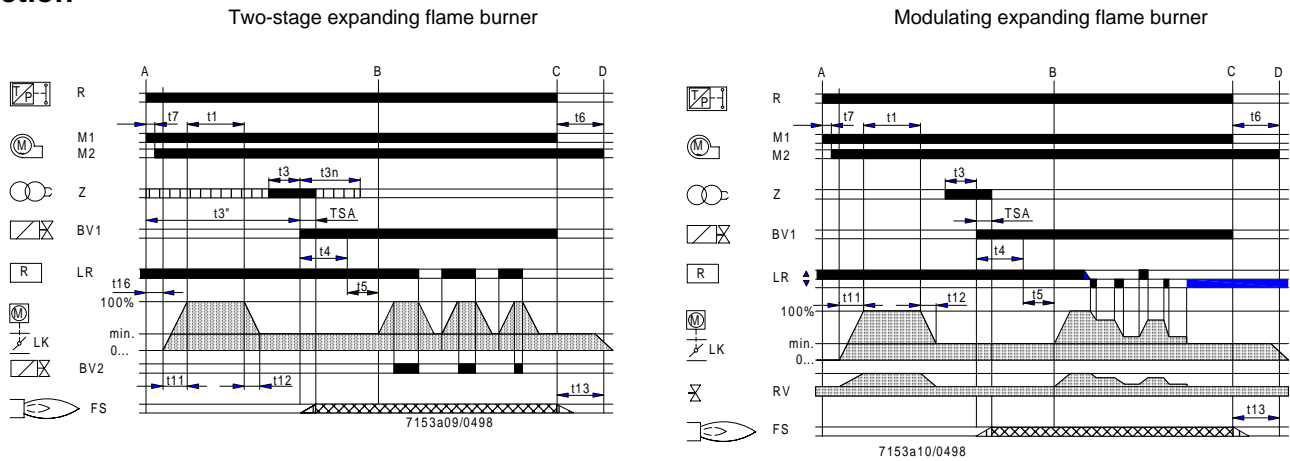

Legend

BV...	Fuel valve	M...	Fan or burner motor
FS	Flame signal amplifier	R	Control thermostat or pressurestat
LK	Air damper	RV	Modulating fuel valve
LR	Load controller	Z	Ignition transformer

General

The following features of the LAL... exceed the standards, thus offering a high level of additional safety:

- Detector and extraneous light test are restarted immediately on completion of the after-burn time «t13».
 - This means that **open** or **not fully closed** valves immediately initiate lockout at the end of «t13».
 - The test ends only on completion of «t1» of the next startup sequence
- The correct functioning of the flame supervision circuit is automatically checked during each burner startup sequence
- The control contacts for the release of fuel are checked for welding during «t6»
- A built-in unit fuse protects the control contacts against overloading

Control of burner

- Burner operation with or without post-purging
- Fan motors with an amperage up to 4 A can be connected directly
 - ⇒ Starting current max. 20 A
- Separate control outputs for
 - pre-ignition from start command
 - post-ignition until shortly before the burner startup sequence is completed
 - short pre-ignition with post-ignition up to the end of «TSA»
- Separate control outputs for the positioning directions OPEN, CLOSE and MIN of the actuator
- Checked air damper operation to ensure pre-purging with the nominal amount of air.
 - Checked positions:
 - CLOSED or MIN on startup ⇒ Low flame position
 - OPEN at the beginning, and
 - MIN on completion of «t1»
 - If the actuator does **not** drive the air damper to the required position, the burner startup sequence will be stopped
- Two control outputs for the release of the second and third output stage, or for load control
- When load control is enabled, the control outputs for the actuator will be galvanically separated from the unit's control section
- Connection facilities for:
 - a remote lockout warning device
 - remote reset
 - remote emergency shutdown
- In addition, with LAL2... / LAL3... / LAL4...:
 - possibility of air pressure supervision with functional test of the air pressure monitor on startup
 - possibility of semi-automatic burner startup

Flame supervision

LAL...

With a photoresistive detector QRB1.... or, optionally,

LAL1... / LAL4...

With a blue-flame detector QRC1... for the supervision of blue-burning oil burners

LAL2... / LAL3...

With a selenium photocell detector RAR... ⇒ Active detector

- Detector and extraneous light test are carried out automatically during the burner off times and the pre-purge time «t1»
- If loss of flame occurs during operation, the burner control initiates lockout
- If automatic repetition of the startup sequence is required, the clearly marked wire link on the plug-in section of the LAL... **must** be cut away ⇒ Start repetition

	LAL1... with		LAL2... / LAL3... with		LAL4... with	
	QRB1...	QRC1...	QRB1...	RAR...	QRB1...	QRC1...
Min. detector current required at AC 230 V	95 µA	80 µA	8 µA	6.5 µA	95 µA	80 µA
Max. detector current required without flame	12 µA	12 µA	0.8 µA	0.7 µA	12 µA	12 µA
Max. detector current that can occur	160 µA	130 µA	35 µA	30 µA	160 µA	130 µA
Instrument's + pole	to term. 23	to term. 23	to term. 22	to term. 22	to term. 23	to term. 23
Length of detector line						
In the same cable as the control lines	max. 30 m	---	not perm.	---	max. 30 m	---
Separate cable in the cable duct	max. 1000 m	---	20 m	RAR7...: 30 m	max. 1000 m	---
Three-wire cable	---	max. 1 m	---	---	---	max. 1 m
Two-wire cable for the detector line (bl, sw); separate single-wire cable for the line (br)	---	max. 20 m	---	---	---	max. 20 m
Shielded cable (e.g. RG62, shielding insulated)	---	---	200 m	RAR8...: 100 m	---	---
Shielding	---	---	to term. 23	---	---	---

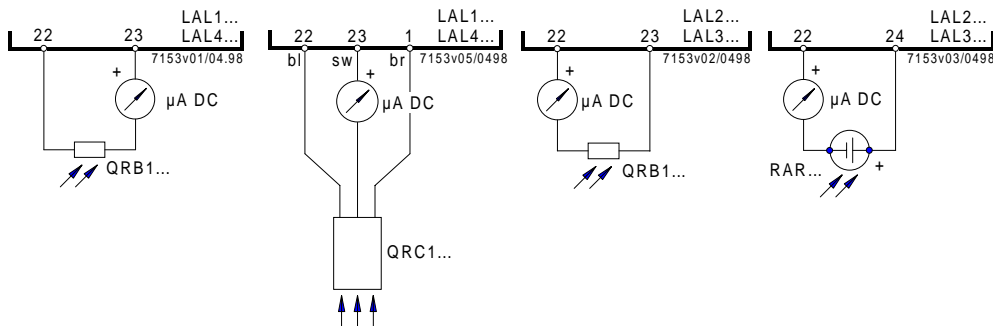

Prerequisites for operation

- If the required input signals are not present,
 - the burner control interrupts the startup sequence at the points marked by symbols
 - the LAL...initiates lockout where this is required by safety regulations ⇒ Refer to diagram
- The symbols used are identical with those on the burner control's lockout indicator

Prerequisites for burner startup

- Burner control **not** interlocked in lockout position
- Sequence switch in start position
 - ⇒ With LAL1..., voltage present at terminals 4 and 11
 - ⇒ With LAL2... / LAL3... / LAL4..., voltage present at terminals 11 and 12
- Air damper closed
- Limit switch «z» for the CLOSED position **must** feed voltage from terminal 11 to terminal 8
- The contact of the limit thermostat or pressure monitor «W» as well as the contacts of any other switching devices in the control loop between terminals 4 and 5 must be closed
 - ⇒ E.g. a control contact for the oil pre-heater temperature

Other prerequisites for burner startup

With the exception of LAL1...

- Control contacts between terminal 12 and «LP» must be closed!
- Normally closed contact of the air pressure monitor **must** be closed ⇒ «LP» test

- Startup sequence**
- A** Start command by «R»
 - ⇒ «R» closes the start control loop between terminals 4 and 5
 - The sequence switch starts to run
 - ⇒ **Only** pre-purging:
 - Fan motor connected to terminal 6 immediately receives voltage
 - ⇒ Pre- and post-purging:
 - Fan motor or flue gas fan connected to terminal 7 receives voltage on completion of «t7»
 - On completion of «t16», the control command for opening the air damper is given via terminal 9
 - Terminal 8 receives no voltage during the positioning time
 - The sequence switch continues to run only after the air damper has fully opened
 - t1** Pre-purge time with air damper fully open
 - During «t1», the correct functioning of the flame supervision circuit is checked
 - The burner control goes to lockout if correct functioning is not ensured

With LAL2... / LAL3... / LAL4...

Shortly after the beginning of «t1», the air pressure monitor **must** change over from terminal 13 to terminal 14.

 - ⇒ Otherwise, the burner control will initiate lockout
 - ⇒ Start of air pressure check
 - TSA** Ignition safety time

On completion of «TSA», a flame signal **must** be present at terminal 22. It must always be available until controlled shutdown occurs.

 - ⇒ Otherwise, the burner control will initiate lockout and lock itself in the lockout position
 - t3** Short pre-ignition time

«Z» **must** be connected to terminal 16, release of fuel via terminal 18.
 - t3'** Long pre-ignition time

«Z» connected to terminal 15.

With LAL1...

«Z» is switched on when the start command is given.

With LAL2... / LAL3... / LAL4...

«Z» is switched on only when «LP» changes over.

 - ⇒ No later than at the end of «t10»
 - On completion of «t1», the LAL... via terminal 10 drives the air damper to the low flame position
 - ⇒ The low flame position is determined by the changeover point of auxiliary switch «m» in the actuator
 - During the positioning time, the sequence switch does not move
 - ⇒ Until terminal 8 receives voltage via «m»
 - The sequence switch motor is connected to the control section of the LAL...
 - ⇒ Positioning signals fed to terminal 8 have no influence now on the further startup sequence and the subsequent burner operation
 - t3n** Post-ignition time
 - «Z» **must** be connected to terminal 15
 - With short pre-ignition, «Z» remains switched on until «TSA» has elapsed
 - ⇒ Connection to terminal 16
 - t4** Interval «BV1-BV2» or «BV1-LR»
 - On completion of «t4», voltage is present at terminal 19
 - The voltage is required to supply power to «BV2» connected to auxiliary switch «v» in the actuator
 - t5** Interval
 - On completion of «t5», terminal 20 receives voltage.
 - At the same time, control outputs 9 to 11 and input 8 are galvanically separated from the LAL...’s control section
 - ⇒ The LAL... is now protected against reverse voltages from the load control circuit
 - With the release of «LR» at terminal 20, the start-up sequence of the burner control ends
 - After a few idle steps (steps without contact position changes), the sequence switch switches itself off

- B** Operating position of the burner
- B-C** Burner operation
- During burner operation, «LR» drives the air damper to the nominal load or low flame position, depending on heat demand
 - Release of the nominal load is given by auxiliary switch «v» in the actuator
 - **In the event of loss of flame during operation, the LAL... initiates lockout**
 - **For automatic repetition of the startup sequence, the clearly marked wire link «B» on the plug-in section of the LAL... must be cut away**
- C** Controlled shutdown
- In the case of a controlled shutdown, the «BV...» will immediately be closed. At the same time, the sequence switch is started to program «t6».
- C-D** Sequence switch travels to the start position «A»
- t6** Post-purge time
- Fan «M2» connected to terminal 7
 - Shortly after the start of «t6», terminal 10 receives voltage
 - ⇒ Air damper is driven to the MIN position
 - Complete closing of the air damper starts only shortly before «t6» has elapsed
 - ⇒ Initiated by the control signal at terminal 11
 - During the following burner off time, terminal 11 remains under voltage
- t13** Permissible after-burn time
- During «t13», the flame signal input may still receive a flame signal
- ⇒ No lockout
- D-A** End of control program
- ⇒ Start position
- As soon as the sequence switch has reached the start position, having thereby switched itself off, the detector and extraneous light test will start again.

During burner off times, the flame supervision circuit is under voltage.

When the start position is reached:

With LAL1...: a voltage signal is fed to terminal 4

With LAL2... / LAL3... / LAL4...: a voltage signal is fed to terminal 12

Control program under fault conditions and lockout indication

Whenever a fault occurs, the sequence switch stops and with it the lockout indicator.

The symbol above the reading mark of the indicator gives the type of fault:			
◀	No start	• One of the contacts has not closed	Also refer to «Prerequisites for burner startup»
		• Extraneous light	Lockout during or after completion of the control program Examples: – Flame not extinguished – Leaking fuel valves – Faulty flame supervision circuit
▲	Interruption of startup sequence	• OPEN signal of changeover limit switch «a» has not been delivered to terminal 8	
		• Terminals 6, 7 and 15 remain under voltage until fault has been corrected	
P	Lockout	• No air pressure indication at the beginning of the air pressure check	Does not apply to LAL1...
■	Lockout	• Air pressure failure after air pressure check	Does not apply to LAL1... • Defect in the flame supervision circuit, faulty flame signal, extraneous light
▼	Interruption of startup sequence		• Position signal of auxiliary switch «m» for the low flame position has not been delivered to terminal 8
1	Lockout		• Terminals 6, 7 and 15 remain under voltage until fault has been corrected
I	Lockout		• No flame signal present on completion of the safety time
			• Flame signal has been lost during operation

Lockout indicator

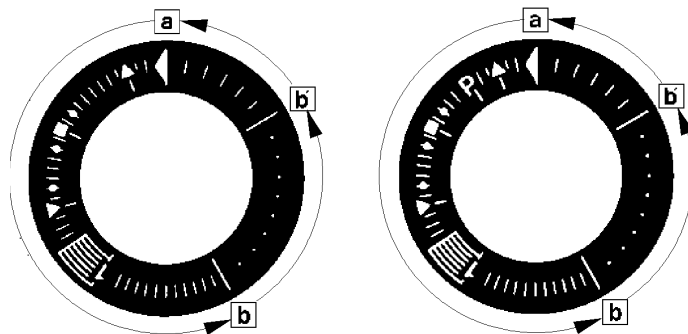

LAL1...

LAL2... / LAL3... / LAL4...

- a-b Startup sequence
- b-b' Idle steps (without contact confirmation)
- b(b')-a Post-purge program

- Burner control **can be reset** immediately after a lockout
 - **Do not press the lockout reset button for more than 10 seconds!**



- First, the sequence switch always travels to the start position
 - after resetting
 - after rectification of a fault which had led to a shutdown
 - after each power failure
 During this period of time, voltage is **only** fed to terminals 7, 9, 10 and 11
- Then, the LAL... programs a new burner startup

Connection diagrams

LAL1...

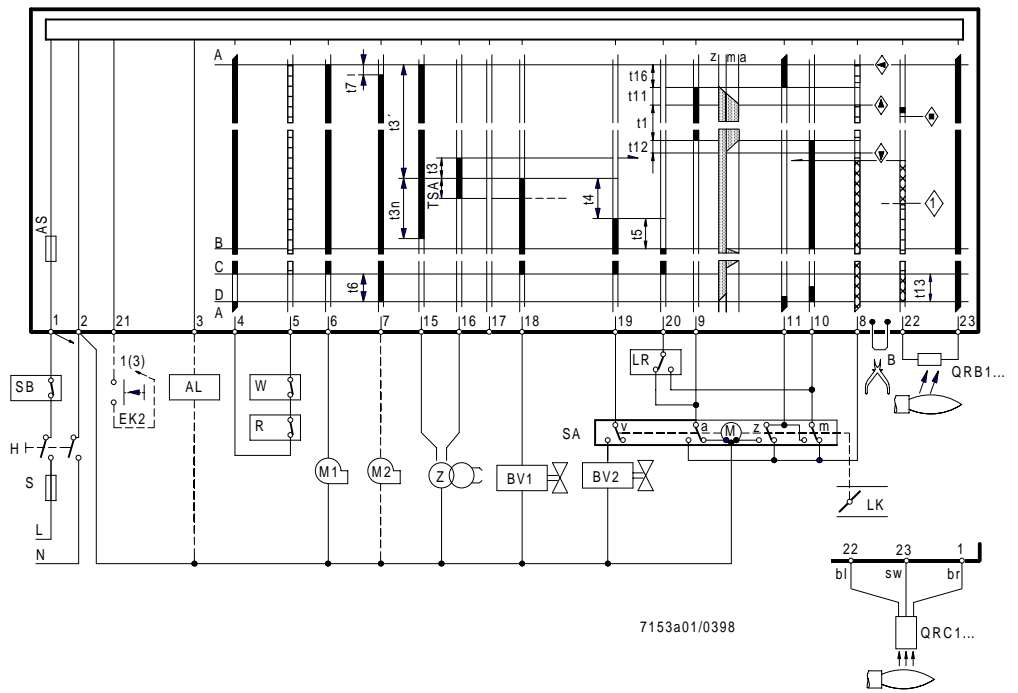

For variants, refer to «Connection examples»

LAL2... / LAL3...

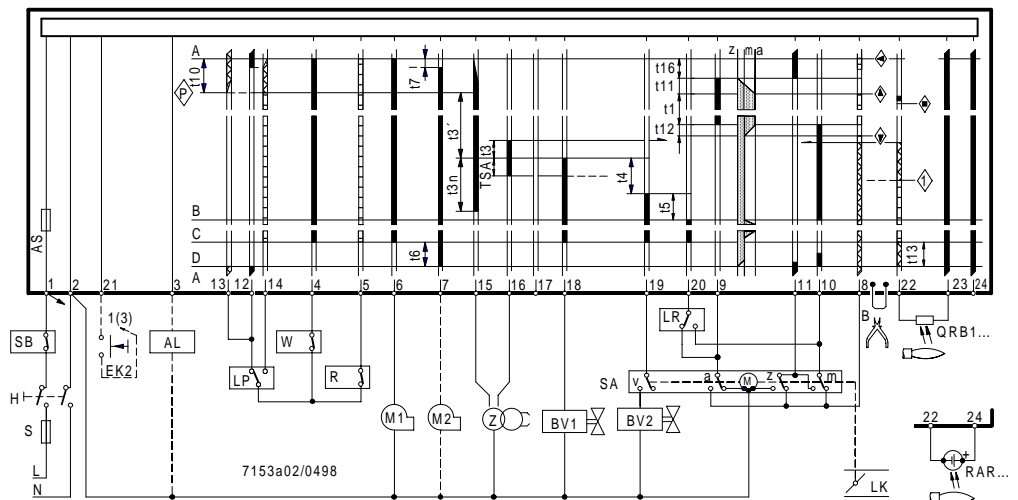

For variants, refer to « Connection examples »

LAL4...

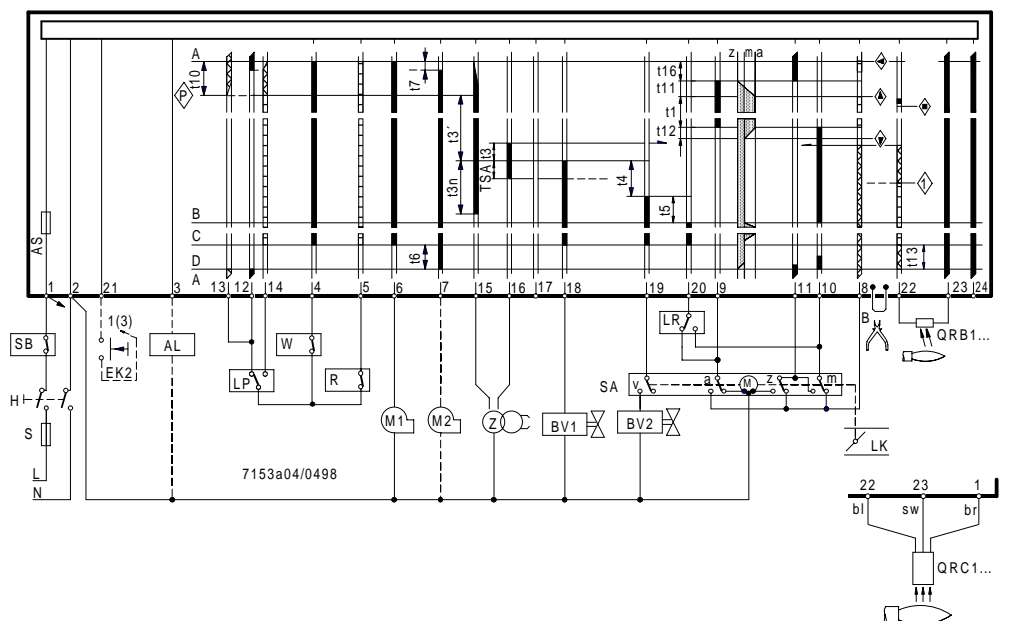

For variants, refer to « Connection examples »

Sequence diagram

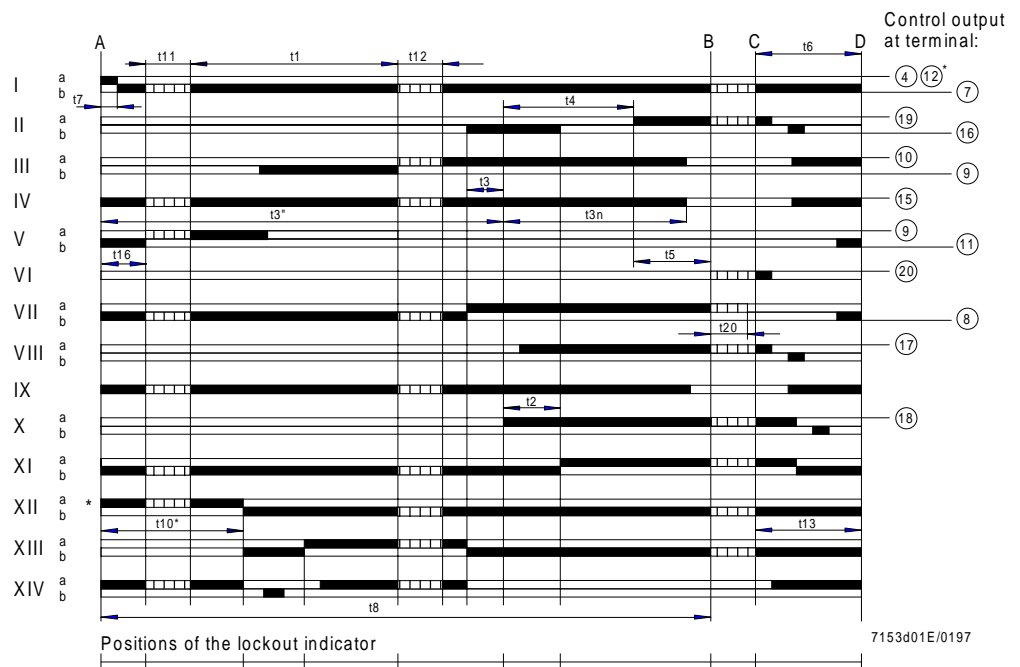

Legend

a	Changeover limit switch for air damper's OPEN position	QRC1...	Blue-flame detector
AL	Remote lockout indicator (alarm)	QRB1...	Photoresistive detector
AS	Unit fuse	RAR...	Selenium photocell detector
B	Wire link	S	Fuse
bl	blue	SA	Air damper actuator
br	brown	sw	black
EK...	Lockout reset button	v	In the actuator: auxiliary changeover switch for position-dependent release of fuel
H	Mains isolator	W	Control thermostat or pressurestat
LP	Air pressure monitor	z	In the actuator: limit switch for air damper's CLOSED position
m	Auxiliary changeover switch for air damper's MIN position		
	Control signals delivered by LAL...		Permitted input signals
	Required input signals:		
	If these signals are not present during or , the burner control will stop the startup sequence and initiate lockout		
TSA	Ignition safety time	t7	Interval between start command and voltage at terminal 7 (start delay time for «M2»)
t1	Pre-purge time with air damper open	t8	Duration of startup sequence (excluding «t11» and «t12»)
t3	Pre-ignition time, short («Z» connected to terminal 16)	t10	Only with LAL2... / LAL3... / LAL4...: interval from startup to beginning of air pressure check
t3'	Pre-ignition time, long («Z» connected to terminal 15)	t11	Air damper running time to OPEN position
t3n	Post-ignition time («Z» connected to terminal 15)	t12	Air damper running time to low flame position (MIN)
t4	Interval between voltage at terminals 18 and 19 («BV1-BV2»)	t13	Permissible after-burn time
t5	Interval between voltage at terminals 19 and 20 («BV2» load controller)	t16	Interval to the OPEN command for the air damper
t6	Post-purge time (with «M2»)	t20	Not with all LAL...: for self-shutdown of sequence switch
*	These data do not apply to LAL1...		

Connection diagrams

LAL1...

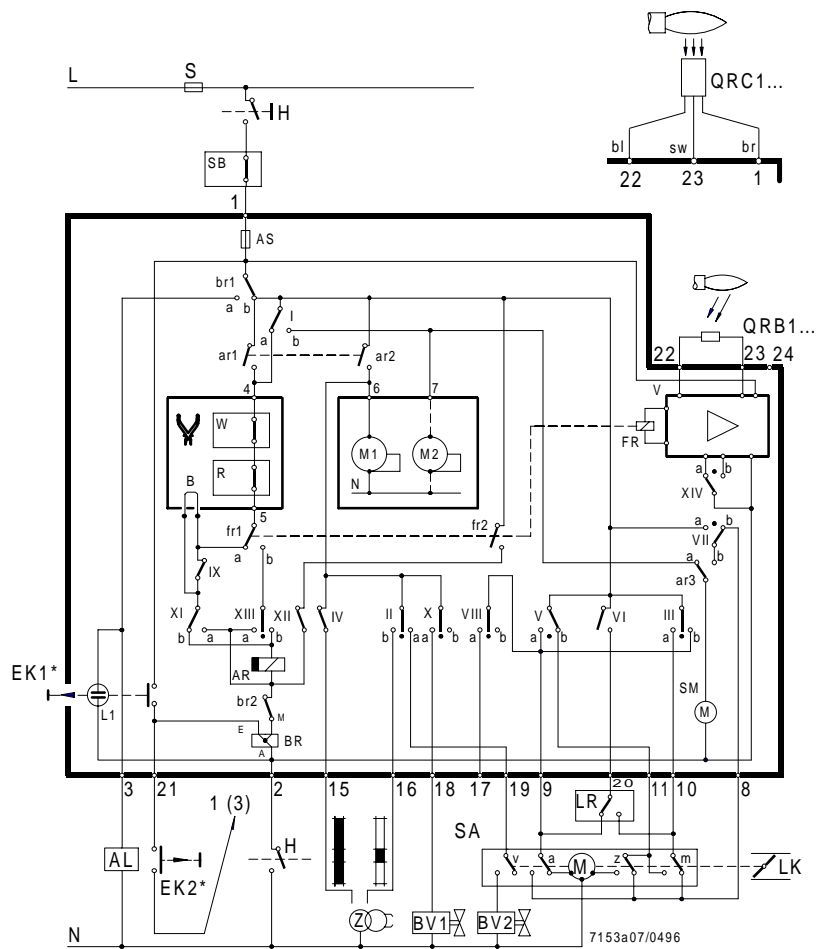

LAL2... / LAL3...

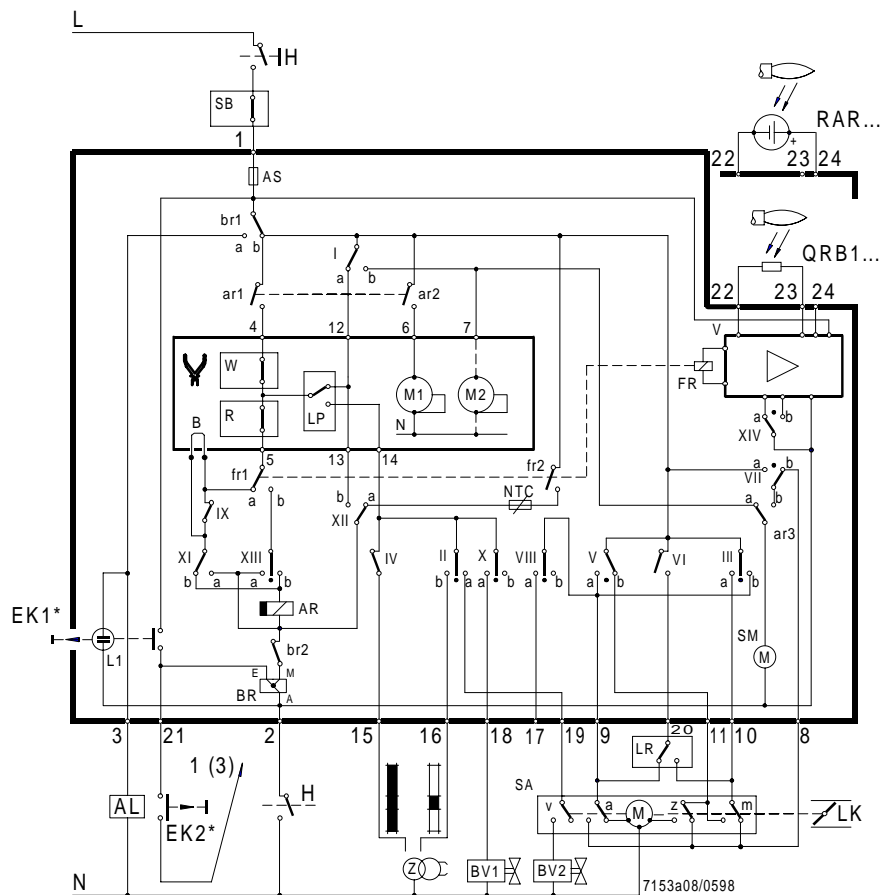

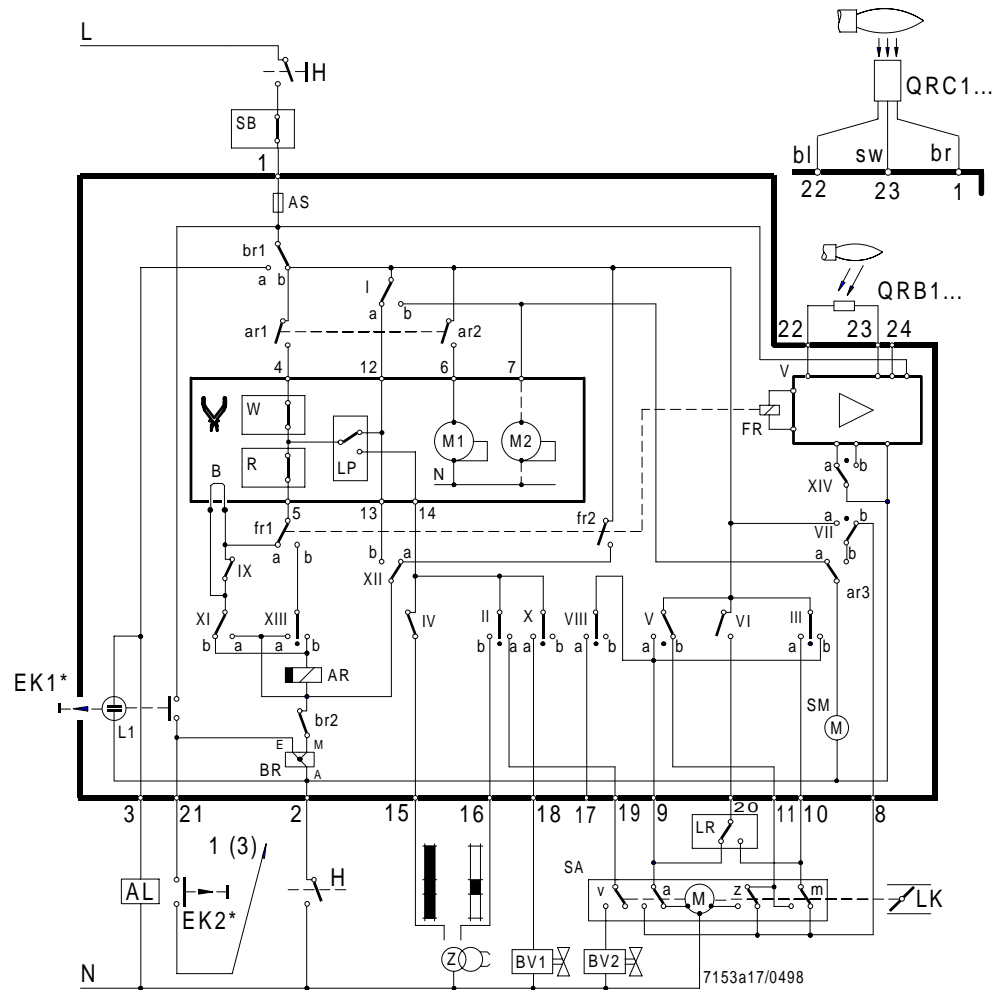

Do not press the lockout reset button for more than 10 seconds!

Legend

AR	Load relay with contacts «ar...»	NTC	Resistor (negative temperature coefficient)
BR	Lockout relay with contacts «br...»	SM	Synchronous motor of sequence switch
FR	Flame relay with contacts «fr...»	V	Flame signal amplifier
L...	Lockout warning lamp		Pre- and post-ignition when «Z» is connected to terminal 15

Connection examples

Connection of actuators without changeover limit switch for the CLOSED position

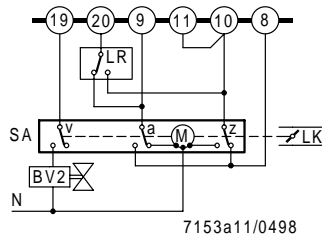

«z» adjusted to air volume for low flame operation

Control of actuator during operation by control signals fed to terminal 17

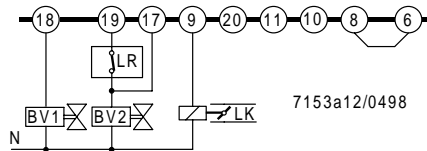

For signal path, refer to «Connection diagrams»

Control of «BV...» via terminal 20

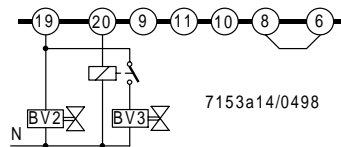

The relay is not required if «BV3» connected to terminal 20 is hydraulically series-connected with «BV2».

«BV2» is controlled by terminal 18 or terminal 19.

⇒ Burner without air damper or with an air damper **not** controlled by the LAL...

Wiring required with LAL2... for operation without air pressure supervision

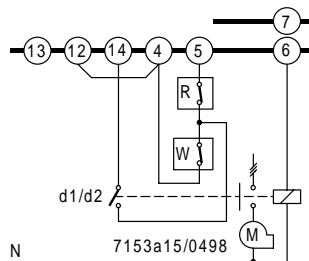

If an auxiliary contact «d1 / d2» of the fan contactor is included in the circuit as shown in the diagram, ignition and release of fuel are possible **only** when the contact is closed.

Semi-automatic startup

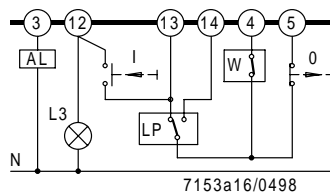

The burner is switched on manually by pressing button «I».

Then, LAL... programs startup and flame supervision.

Burner shutdown is also manual by pressing button «0», or automatically when limit thermostat or pressure monitor «W» responds.

«L3» indicates when the burner is ready for startup. It extinguishes shortly after the burner is started up.

For other connections, refer to «Connection diagrams».

Two-stage expanding flame burner

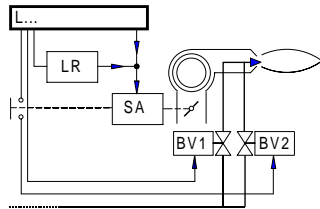

Load control with an on / off controller.
During burner off times, the air damper is closed.

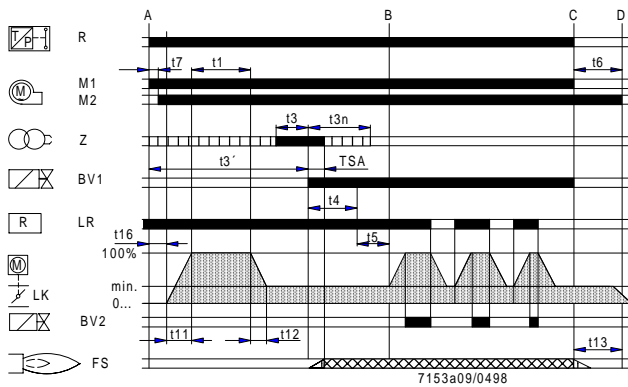
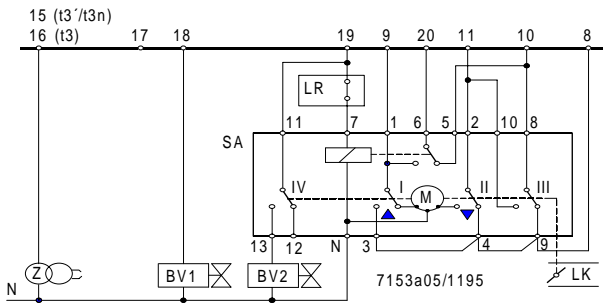

Control of actuator based on single-wire control.

⇒ Actuator «SA» type SQN...,
refer to data sheet 7808.

For other connections, refer to «Connection diagrams»

 Pre- and post-ignition when ignition transformer is connected to terminal 15

Modulating expanding flame burner

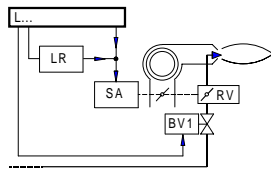

Load control with a modulating controller with galvanically separated control contacts for OPEN and CLOSED positions.

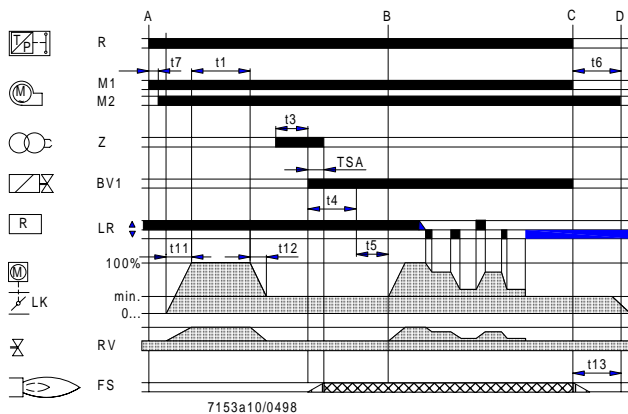
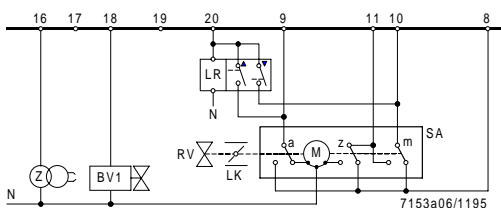

During burner off times, the air damper is closed.

When using actuators without changeover limit switch «z» for the CLOSED position, terminals 10 and 11 must be interconnected.

For other connections, refer to «Connection diagrams».

Dimensions

LAL... with base
AGM410490500

Dimensions in mm

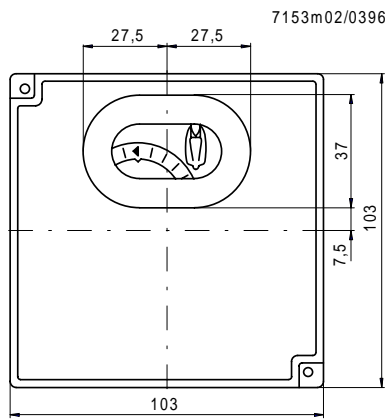
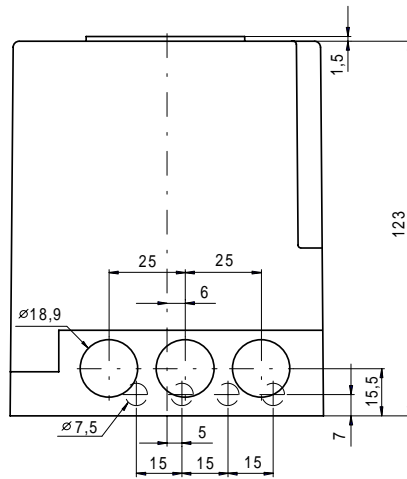

Base AGM410490500

